

SIEMENS

**Gigaset
3000
Micro**



ENGLISH

Operating Instructions

and Safety Precautions 

 Information and Communications

Brief overview



The display is protected by a film.
Please remove protective film.



Idle display, display keys



Reception range

Current functions

of the display keys, e.g. network access list, caller list*, calling internal number, redialling number

Display keys

- Functions vary depending on the display
- **If there are 2 functions**, press either the left **or** right side of the key

* Dependent on the base station, country and carrier services

Important menus

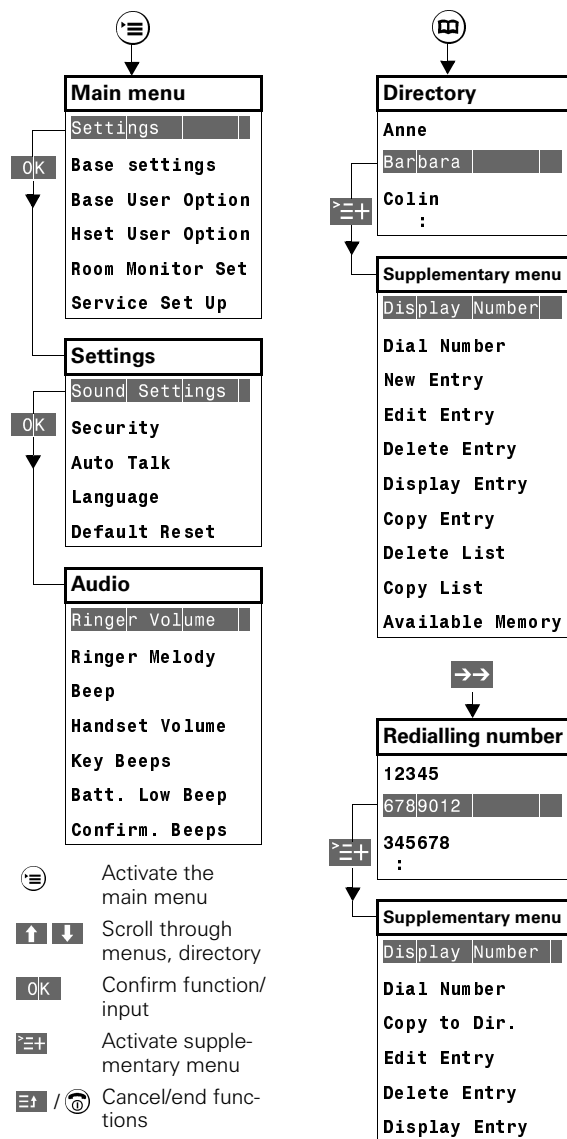











Safety precautions

- Never use ordinary (non-rechargeable) batteries. Only use **the V30145-K1310-X143 battery supplied** (rechargeable), otherwise the battery casings may be destroyed (dangerous).
- The following symbol is displayed in the battery compartment:
 Use battery type in accordance with these operating instructions.
- **Only** use the **plug-in power supply unit supplied** as indicated on the underside of the charging unit.
- Do not use third-party charging units as these can damage the battery.
- The battery warms up during charging; this is normal and not dangerous.
- The operation of medical equipment can be affected by the handset.
- The handset can cause an unpleasant humming noise in hearing aids.
- Do not operate the handset in environments where there is risk of explosion, such as paint shops.
- Please remember to include the operating instructions when passing your handset on to a third party.
- Please dispose of the battery in an environmentally friendly manner in accordance with the relevant legislation.

Display symbols

The following symbols appear in display, depending on the operating situation:

	Network access list		Internal dialling
	On/off		Redialling number
	Left/right		Confirmation
	Mailbox function: e.g. new entry in the caller list		End function
	Delete character		Cancel/higher menu level
			Supplementary menu

Contents

Brief overview	2
Idle display, display keys	2
Important menus	3
Safety precautions	4
Display symbols	4
Preparing the handset	6
Inserting the battery	6
Connecting the charging unit	7
Wall-mounting the charging unit	7
Charging the battery	8
Fitting the attachment clip	8
Activating/deactivating the handset	9
Activating/deactivating the keypad lock	9
Registering the handset	10
Making calls	11
Making external calls	11
Direct internal dialling	11
Answering a call	11
Transferring an external call, making an enquiry call	12
Redial	13
Directories	14
Storing a call number	14
Dialling from the directory	14
Entering names	15
Network access support	17
Caller list	18
Audio settings	18
Handset volume	18
Ringer volume/melody	19
Setting short beeps (advisory beep)	19
Activating/deactivating the ringer	19
Activating/deactivating warning and signal beeps	19
Security	20
Changing the telephone PIN	20
Hot key selection (direct station selection)	21
Telephone lock	21
Dialling the emergency number	22
Further settings	22
Auto talk	22
Setting the display language	22
Resetting the handset to the default configuration	23
Base settings	24
Registering the handset	24
User options (short cuts)	25
Room monitor	27
Appendix	28

Preparing the handset

Contents of the package

Enhanced Gigaset 3000 Micro handset, battery, belt clip, charging unit, plug-in power supply unit, operating instructions.

Inserting the battery



- Never use ordinary (non-rechargeable) batteries. Only use **the V30145-K1310-X143 battery supplied** (rechargeable), otherwise the battery casings may be destroyed (dangerous).
- The following symbol is displayed in the battery compartment:
 Use battery type in accordance with these operating instructions.
- Do not use third-party charging units as these can damage the battery.
- Please dispose of the battery in an environmentally friendly manner in accordance with the relevant legislation.

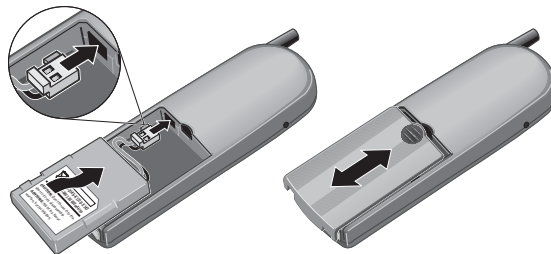

- Insert the **battery connector** with the **little protusion facing up and left** in the socket (incorrect insertion impossible) and then place the battery in the compartment – see figure.
- Slide the cover approx. **3 mm into the battery compartment** and push gently forwards until it clicks into place.
- **To open** the cover, press the grooved area on the cover and slide **back**.

Connecting the charging unit

 **Only use the plug-in power supply unit supplied.**

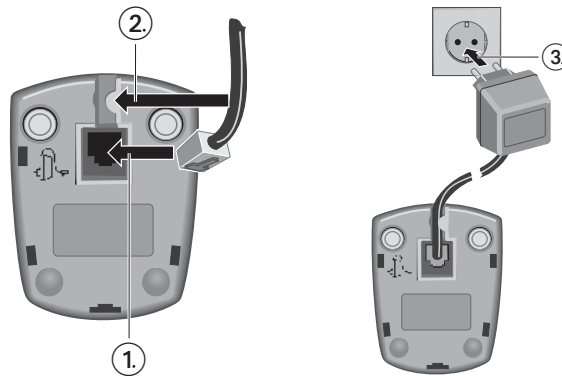

Wall-mounting the charging unit

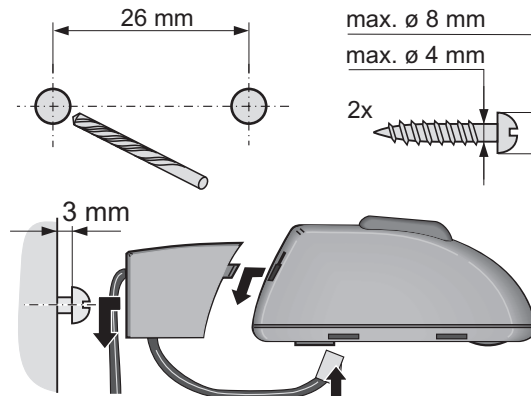

Charging the battery

The battery is supplied **uncharged**.

To charge the battery, insert the handset either into the base station or the Gigaset 3000L Micro charging unit – you will hear the confirmation beep. The charging operation is indicated by a flashing LED on the handset:

	Battery empty		Battery $\frac{2}{3}$ charged
	Battery $\frac{1}{3}$ charged		Battery full

- Initially charge the batteries **thoroughly**; we recommend charging the batteries for at least **16 hours without interruption** – irrespective of the charging status icon.
- Once the first charging operation is complete, you can replace the handset in the base station after any call. Charging is controlled electronically. This ensures optimum charging and prolongs battery life.
- The battery warms up during charging. This is normal and not dangerous.
- The battery charging status is only correctly displayed after uninterrupted charging/discharging.

Approved battery:

Toshiba Power Pack (NiMH), order no. V30145-K1310-X143.

Battery operating times/charging times:

Capacity (mAh)	Standby time (hours)	Talktime (hours)	Charging time (hours)
600	up to 200	approx. 15	approx. 5

Fitting the attachment clip

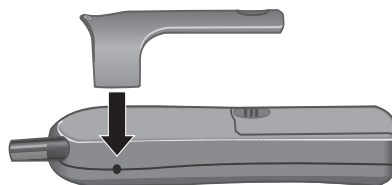

Push the clip onto the back of the handset until the protrusions slot into place.

Activating/deactivating the handset



Press the end call key for **1 second**.

The handset automatically activates when the battery is inserted and when the handset is placed in the base station/charging unit.

Activating/deactivating the keypad lock

Key activation is ineffective when the keypad lock is enabled.

To answer an incoming call, press the talk key  – the keypad lock is automatically disabled for the call.



To activate/deactivate, press and hold down for **longer than 1 second**.

Registering the handset

You can change the display language* (see page 22). After doing this, switch your handset off and then on again.

You must register a new handset at the base station before you can make any telephone calls. When you switch on your handset, the message **Register?** appears.

Step 1:

- You must first prepare the **Siemens base station**:

Gigaset	Preparing the base station
3010 Micro 3010/3015	Press the coloured key on the base station for approx. 10 seconds until you hear the signal tones .
3020, 3025 3030, 3035	In the base station menu select registration option and confirm.
ISDN models	Press the LED – flashes during registration.
1000/2000 models	See above for appropriate successor models in the 3000 range, e.g. 3010 for 2010.

Step 2:

- Now enter the following **in the handset within one minute**:

YES

Press the display key.

Enter base PIN

OK

Enter the base station's system PIN (factory setting: 0000) and confirm – unassigned internal numbers are displayed.

e.g. **2**^{ABC}

Enter the required call number – the base name, e.g. **Base 1**, is displayed (no longer flashing).

Your handset is now ready for use!

- To register at multiple base stations or to change base names, see page 24.
- To modify the internal call number: re-register your handset at the same base, see page 24.

* English is the default factory setting

Making calls

Making external calls



Enter the call number.
If necessary, correct with



Press the talk key to start dialling.

Ending a call:

Press the end call key

- You can **cancel the dial operation** with the end call key .
- You can enter a **pause** with the recall key (hold down key).
- You can opt to **not save entries**, e.g. when controlling external telephone services: press the menu key , select **Switch to Tone** and confirm with - **none** of the numbers entered afterwards will be saved.

Direct internal dialling



Press the display key – your own internal number is displayed.

e.g.

Enter the internal call number.

To call all handsets:

or

Ending a call:

Press the end call key .

Answering a call



Press the talk key

or



Remove the handset if it is sitting in the base station - the connection is set up without key activation ("Auto. Talk" - default setting).

To immediately deactivate the ringer: hold down.

The call can be accepted while it appears on the display by pressing the talk key .

Transferring an external call, making an enquiry call

Siemens base stations allow you to transfer an external call to another handset or to hold a call while making an internal enquiry call.

INT Press the display key.

e.g. **2^{ABC}** Dial the internal number.

When the user answers:

- **transfer the call:** press the end call key **Ⓣ**.
- **end the enquiry call:** press **Ⓡ** to revert to the caller placed on hold.

Redial

You can access the last call numbers dialled.



Display and select the call number.



Start the dial operation.

Additional functions

All functions in the supplementary menu start as follows:



Display and select call numbers.



Open the supplementary menu.



Select the **required function** and confirm:

Display Number (further numbers can be added before dialling);

Dial Number (the selected call number is dialled);

Copy to Dir. (the call number can be saved in the telephone directory);

Edit Entry (change the call number);

Delete Entry (delete the call number);

Display Entry (the whole call number is displayed).











Directories



With the **directory** , you can store up to 100 call numbers and then dial them at the push of a button.

You can store prefixes for telephone companies and frequently used call numbers in the **network access list**  (see also Network access support, page 17).







Apart from the entry operation, using the directory and the network access list is identical.

Storing a call number

-  /  Display the directory/network access list.
-  Open the supplementary menu.
-   Select **New Entry**.
- Name** Enter the name, see page 15.
-  Scroll to the next line.
-  Enter the call number, see also note below.
-  Open the supplementary menu.
-   Confirm **Save Entry**.

- When entering the number, you can insert a pause with the recall key  or a number from the network access list via the supplementary menu .
- You can, for example, store the number of a company's switchboard so that you only have to dial the extension when making a call.
- You can also save incoming or outgoing call numbers during a call.













Dialling from the directory

-  /  Display the directory/network access list.
- e.g.   Enter the first letters of the name, e.g. press the key  twice for "E" or scroll with .
-  Press the talk key to start dialling.

Entering names

To enter **names**, you can choose letters, digits and symbols with the appropriate key:

Press the appropriate key repeatedly or hold it down:

	1x	2x	3x	4x	5x	6x	7x	8x	9x
	1								
	a	b	c	2	ä	à	â	ã	ç
	d	e	f	3	ë	é	è	ê	
	g	h	i	4	ï	î			
	j	k	l	5					
	m	n	o	6	ö	ñ	ó	ô	õ
	p	q	r	s	7	ß			
	t	u	v	8	ü	ú	ù	û	
	w	x	y	z	9	ý	æ	ø	á
	␣*	.	-	0	,	+	:	?	!
	a→A	*	/	()	=	&	@	
	#	£	\$						

* Blank

The entries are sorted as follows:

*, #, space, digit (0-9), letter (in alphabetical order), -, other characters.

Upper/lowercase:

The **first letter** of the name is **written automatically in upper case**, the letters immediately afterwards are written in lower case.



Manual shift to upper/lower case for **one character**.

Controlling the cursor:



Move the cursor to the left or right or to the end of the word/line in the next line (press briefly or hold down).



Scroll up or down one line.

Deleting a character:



The character to the left of the cursor is deleted (press briefly or hold down).

Inserting characters:

Characters are always inserted to the left of the cursor.

Additional functions



Display the directory/network access list.

e.g.

Enter the first letter of the name, e.g. press for "T".



Open the supplementary menu.



Select the **required function** and confirm:

Display Number (further numbers can be added);

Dial Number (the call number is dialled);

New Entry (see page 14);

Edit Entry (change the call number/name);

Delete Entry (delete the call number);

Display Entry (the whole call number is displayed);

Copy Entry

Prerequisite: both handset and base station support this function.

You can copy the entry to another Comfort handset.

If **Copy entry to INT Hset:** is displayed:

e.g.

Enter the number of the handset called and confirm.

The **handset called** rings:

e.g.

Accept the call.

Tel. PIN

Enter the telephone PIN of the handset called and confirm – the entry is transferred.

Delete List

All entries are deleted.

Copy List

Procedure as for "Copy Entry".

Available Memory

Indicates the memory available. This is shared by the directory, the network access list and the short cuts.

Network access support

• Linking call numbers

This function allows you to merge two parts of a number.



Open the network access list and select an entry.



Open the supplementary menu.



Confirm **Display Number** – the number is displayed.

e.g.

Either enter the user's call number **or** open the directory and select a number.



Start the dial operation – the two parts of the call numbers are dialled one after the other.

• Speed dialling from the network access list

- You can save 10 numbers (**0-9**) in the call-by-call list for speed dialling. These **speed dialling numbers (0-9)** must be entered **before** the name, e.g. "**1** Name".
- Hold down the relevant digit key (**0-9**) to display the number saved.

Prerequisite: speed dialling number is saved!

e.g.

Hold down the relevant digit key – e.g. 1, and the number saved under the name "**1** Name" is displayed.

e.g.

Enter the user's call number **or** open the directory and select the number.



Start the dial operation – the two parts of the call numbers are dialled, one after the other.

Caller list

Unanswered calls are also, for example, stored in the **caller list***.

New entries in the caller list are indicated by the display symbol .



Press the display key – the caller list, for example, is displayed.



Scroll to the required entry.

e.g. dial the call number:



Press the talk key.

In the case of **base stations with answering machines**, this symbol  also indicates that new messages have been recorded. Please refer to the appropriate operating instructions.

Audio settings

Handset volume

You can set the handset volume to any of three levels – even during a call!



Press the menu key.



Select **Settings**.



Select **Sound Settings**.



Select **Handset Volume**.



Change the volume and save.

* Dependent on the base station, country and carrier services

Ringer volume/melody

- You can choose between **5 ringer volumes**, the **crescendo ring** (increasing volume =C) and **ringer off** (=0).
- You can choose between **10 ringer melodies**.



Press the menu key.



Select **Settings**.



Select **Sound Settings**.



Select **Ringer Volume** or **Ringer Melody**.



Change the setting and save.

Setting short beeps (advisory beep)

A call is signalled by a single short advisory beep when you set the **Beep** function.



Press the menu key.



Select **Settings**.



Select **Sound Settings**.



Select **Beep**.

✓ = activated.

Activating/deactivating the ringer





You can deactivate the ringer if it disturbs you, for example, during a meeting – all calls appear **only on the display**, but can, however, be accepted while displayed by pressing the talk key .



To activate/deactivate this feature, **hold down** the key until the cancelled bell icon appears or disappears.

Activating/deactivating warning and signal beeps







- **Key Beeps:** every keystroke is confirmed.
- **Batt. Low Beep:** the battery needs to be charged.
- **Confirm. Beeps:** confirmation beep (1 beep) at the end of the input/settings and when replacing the handset in the charging unit; error beep (4 short tones) following an incorrect entry.

-  Press the menu key.
-  Select **Settings**.
-  Select **Sound Settings**.
-  Select the **required function**.
-  Activate or deactivate the function.
✓ = beep activated.

Security

You can change the telephone PIN, set up direct station selection or lock your telephone (handset).

The security functions begin as follows:



-  Press the menu key.
-  Select **Settings**.
-   Select **Security**.
- Tel. PIN**  Enter the telephone PIN (factory setting: 0000).
-  Select the **required function**:

Changing the telephone PIN

Important functions/settings are protected by the PIN (**P**ersonal **I**dentification **N**umber) on your handset.

Do not forget your telephone PIN! It can only be reset by calling the **Siemens hotline**, see page 28.

First steps are as described at the start of the **Safety precautions** section, then:

-  Select **Change PIN**.
- Tel. PIN**  Enter the new telephone PIN (4 digits) **twice** and confirm – the new telephone PIN is saved.
- Tel. PIN**  Enter the new telephone PIN (4 digits) **twice** and confirm – the new telephone PIN is saved.

Hot key selection (direct station selection)

This function is not available in all countries!

When hot key selection is **activated, every keystroke** initiates a call to the previously stored hot key number. Sick people and the elderly, for example, can thus summon help in emergencies. The handset, however, can still receive calls. Simply press the talk key  to take incoming calls.

Saving/changing/deleting a hot key number:

First steps are as described at the start of the **Safety precautions** section, page 20, then:



Select **Hot Key Set Up**.
See also note below!



Enter the hot key number, change it or delete it with .



Select the supplementary menu.



Select **Save Entry**.



When entering a number, if necessary open the supplementary menu  and enter **I** for an internal hot key number (e.g. **I3**), a **pause** or a **number from the network access list**.

Activating the hot key:

First steps as described at the start of the **Safety precautions** section, page 20, then:



Select **Hot Key** and activate.
✓ = activated.

Deactivate:  enter the telephone PIN  .

Telephone lock

If the telephone lock is activated, with the exception of the emergency call, all functions are disabled.

The handset, however, can still receive calls. Simply press the talk key  to take incoming calls.

First steps are as described at the start of the **Safety precautions** section, page 20, then:



Select **Handset Lock** and activate.
✓ = activated.

Deactivate:  enter the telephone PIN  .

Dialling the emergency number

When the hot key/telephone lock is activated, you can dial the emergency numbers saved on the base station – see base station operating instructions!

Further settings

Auto talk

If this function is activated, simply remove the handset from the base station/charging unit to answer a call.



Press the menu key.



Select **Settings**.



Select **Auto Talk** and activate or deactivate the function.
✓ = activated.

Setting the display language



Press the menu key.



Select **Settings**.



Select **Language**.
✓ = language set.



Select the language and confirm.

Language setting displays:

Einstellungen	Sprache	Deutsch
Settings	Language	English
Réglages	Langue	Français
Impostazioni	Lingua	Italiano
Ajustes	Idioma	Español
Programações	Língua	Português
Instellingen	Taal	Nederlands

Resetting the handset to the default configuration

The **telephone PIN** is **not** reset, the **directory, network access list** and the **caller list** are **not** deleted.

Handset factory settings:

Language setting	English
Hot key, redial	deleted
Auto talk, key beep, battery low beep, confirmation beeps	on
Handset volume, ringer tone	1
Ringer volume	5
Short beep	off
Room monitor level	2



Press the menu key.



Select **Settings**.



Select **Default Reset**.



Enter the telephone PIN and confirm (factory setting: 0000).

Base settings

Registering the handset

You can operate your handset at up to **4 base stations**. For information on registering at **non-Siemens** GAP base stations, see the relevant base station operating instructions.

- To prepare the **base station**, see page 10.
- Enter the following **in the handset within one minute**:



Press the menu key.



Select **Base settings**.



Open the supplementary menu.



Select **Register**.

System PIN Enter the base station's system PIN (factory setting: 0000) and confirm.

Additional base settings

All other base settings begin as follows:



Press the menu key.



Select **Base settings**.



Select the base and open the supplementary menu.



Select the **required function**:

Change Base Name

You can change the base name, e.g. **Base** to **Internal 3**; in this case, "3" is the handset's internal number.



Select **Chnge Base Name** (Change Base Name).

Name

Enter the required name. For information on entering the name, see page 15.



Select **Save Entry**.

Select Base

You can set the handset permanently to a **specific base station** or to **Best Base – automatic switch** to the base station with the strongest reception.



Select **Select Base**.

ISDN Config.

Only possible in conjunction with some Siemens ISDN base stations. Refer to the appropriate operating instructions.

User options (short cuts)

Base station user options

Only available with Gigaset 3000 base stations!
Refer to the appropriate operating instructions.

Handset user options (handset short cuts)

You can save multiple operating steps (inputs) as a handset "short cut" and assign an appropriate name to it. You can edit and copy short cuts via the supplementary menu  in the same way as directory entries.

Saving handset user options:

Press the menu key.



Select **Hset User Option**.



Open the supplementary menu.



Select **New Entry**.

Name

Enter the name of the short cut.



Scroll to the next line.

Contents

Enter the contents for the short cut.



Open the supplementary menu and confirm **Save Entry**.

Additional supplementary menu functions when entering the short cut contents:

Insert Function

The following letters are displayed for the functions:

C Request PIN	I INT
N Request No.	E End Call
Q Req. Acknowl.	M Temp. Tone
P Insert Pause	



Select a function and confirm.

Show Function

The meaning of the character at the current cursor position is displayed.

Network Access

To insert a number from the network access list.

Starting a handset short cut:



Press the menu key.



Select **Hset User Option**.



Select the required short cut and start it with the talk key.

Room monitor

When the room monitor feature is activated, an **internal call** to another handset is triggered as soon as the noise level in the monitored room reaches the level set. You can hear the noises in the room when you answer the call. The room monitor remains active even after you replace the handset. Calls are only shown on the monitoring handset's display. The **distance** between the handset placed there and the area to be monitored should be between **1 and 2 meters**.

Saving the call number



Press the menu key.



Select **Room Monitor Set**.



Select **Room Monit. No.**



Enter the number of the handset to be called by the monitoring handset and confirm.

If you entered a 2-digit number by accident: enter a "zero" before the number.

Setting the noise level



Press the menu key.



Select **Room Monitor Set**.



Select **Set Level1**.



Change the level and save.
Level 1 = sensitive!

Activating the room monitor

Prerequisite: call number saved.



Press the menu key.



Select **Room Monitor Set**.



Activate **Room Monitoring** and terminate the function.
✓ = activated.

Deactivating the room monitor



The function is deactivated.

Appendix

Settings at the base

The setting options in the **Service Set Up** menu item are dependent on the base station. Refer to the appropriate base station operating instructions.

Range

The range is up to 300 m outdoors and approx. 50 m indoors. The reception strength symbol indicates the strength of radio contact between the base station and the handset:

- ▣▣▣▣ High reception strength
- ▣▣▣▣ Low reception strength

Headset (accessory)

The **Gigaset 3000 Micro** headset leaves both hands free to conduct calls. Moreover, additional parties can listen in to the calls on the handset.



Guarantee/service

Over a guarantee period of six months from the date of purchase from the stockist, Siemens AG will rectify all material or manufacturing defects by repairing or replacing the defective terminal.

The guarantee does not cover damage caused by incorrect use, wear and tear, or third-party access. The guarantee does not cover consumables or defects which only have a minor effect on the value or operability of the terminal.

Service telephone number see back cover.

Approval

The Gigaset 3000 Micro handset has been approved throughout the EU.